

DRIVE 1

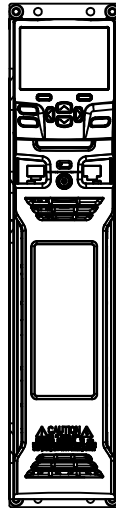

SI UNIVERSAL ENCODER

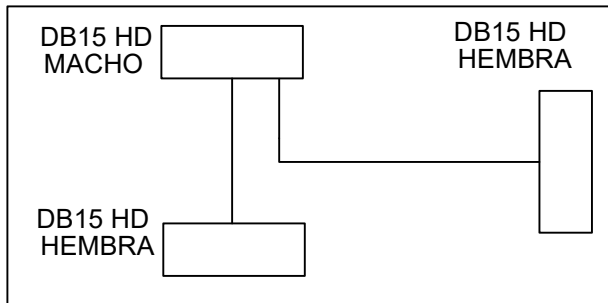
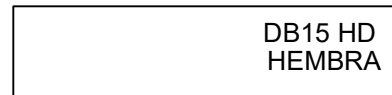

ETCBL0007

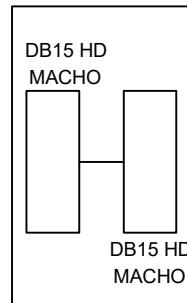

ETADP0001

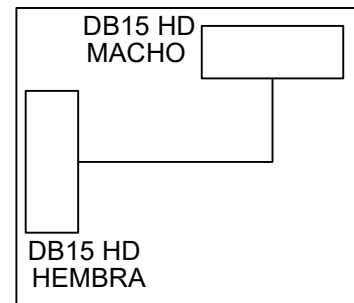

ETCBL0003

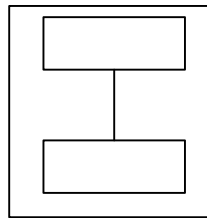
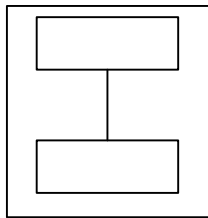

ETCBL0004 SinCos
ETCBL0005 Resolver

ETCBL0003

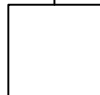
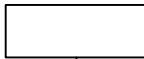

Encoder Incremental
A/A B/B C/C

CABLES/ADAPTADORES UTILIZADOS	
Codigo	Cantidad
ETCBL0003	2
ETCBL0007	1
ETCBL0004 / 5	1
ETADP0001	1

DIBUJO:	AORL	FECHA:	03/12/21	ESCALA:	
REV.:		MEDIDA:			
APR.:	AORL	TOLERANCIA:	+/- MM		
FOLIO:	01/01	MATERIAL:			

ARCHIVO:	
EURO	TECHNIQUES

ESQUEMA DE PRINCIPIO

**Conexion IN Feedback con
Replica a SI Univ Encoder**

Ciente:	Esquema 4	Bl.	Q100
---------	------------------	-----	------