

DRIVE 1

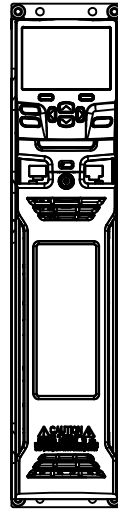

DRIVE 1

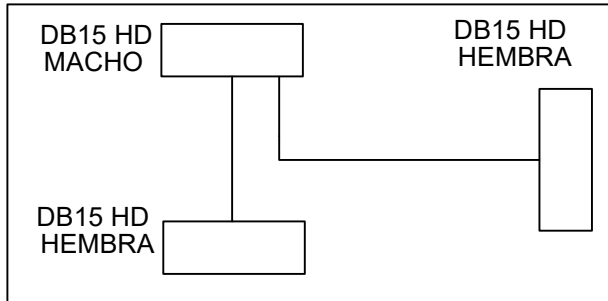

ETCBL0007

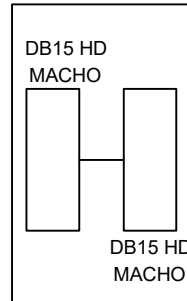

ETADP0001

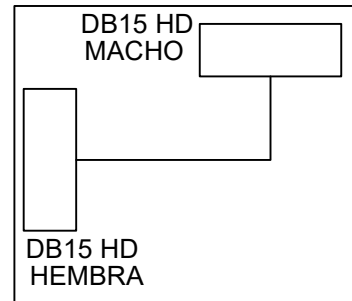

ETCBL0003

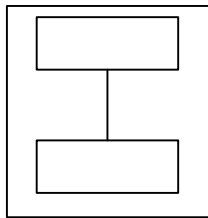

ETCBL0003

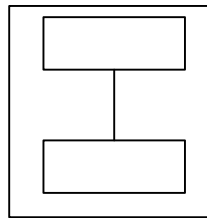

ETCBL0004 SinCos
ETCBL0005 Resolver

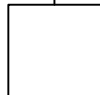
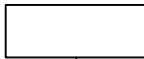

Encoder Incremental
A/A B/B C/C

CABLES/ADAPTADORES UTILIZADOS	
Codigo	Cantidad
ETCBL0003	2
ETCBL0007	1
ETCBL0004 / 5	1
ETADP0001	1

DIBUJO: AORL	FECHA:	ESCALA:
REV.:	03/12/21	MEDIDA:
APR.: AORL		TOLERANCIA: +/- MM
FOLIO: 01/01		MATERIAL:

ARCHIVO:	ESQUEMA DE PRINCIPIO
EURO	TECHNIQUES

**Conexion IN Feedback con
Replica a otro drive**

Ciente:	Esquema 1	Bl.	Q100
---------	------------------	-----	------